

VILLA LAGOON TILE

BREEZE BLOCKS FOR A NEW GENERATION



Hello.

The Villa Lagoon Tile team share a passion for hand-crafted tile and breeze blocks. Based on the US Gulf Coast, we serve clients worldwide. We have tile makers in several countries which provide tile for residential and hospitality projects everywhere.

Keeping Craft Alive.

OUR MISSION is to bring the world's best handmade tile artisans to architects and designers to create signature custom looks and unique design elements for hospitality and residential projects.



VillaLagoonTile.com

Handcrafted Tile & Breeze Blocks



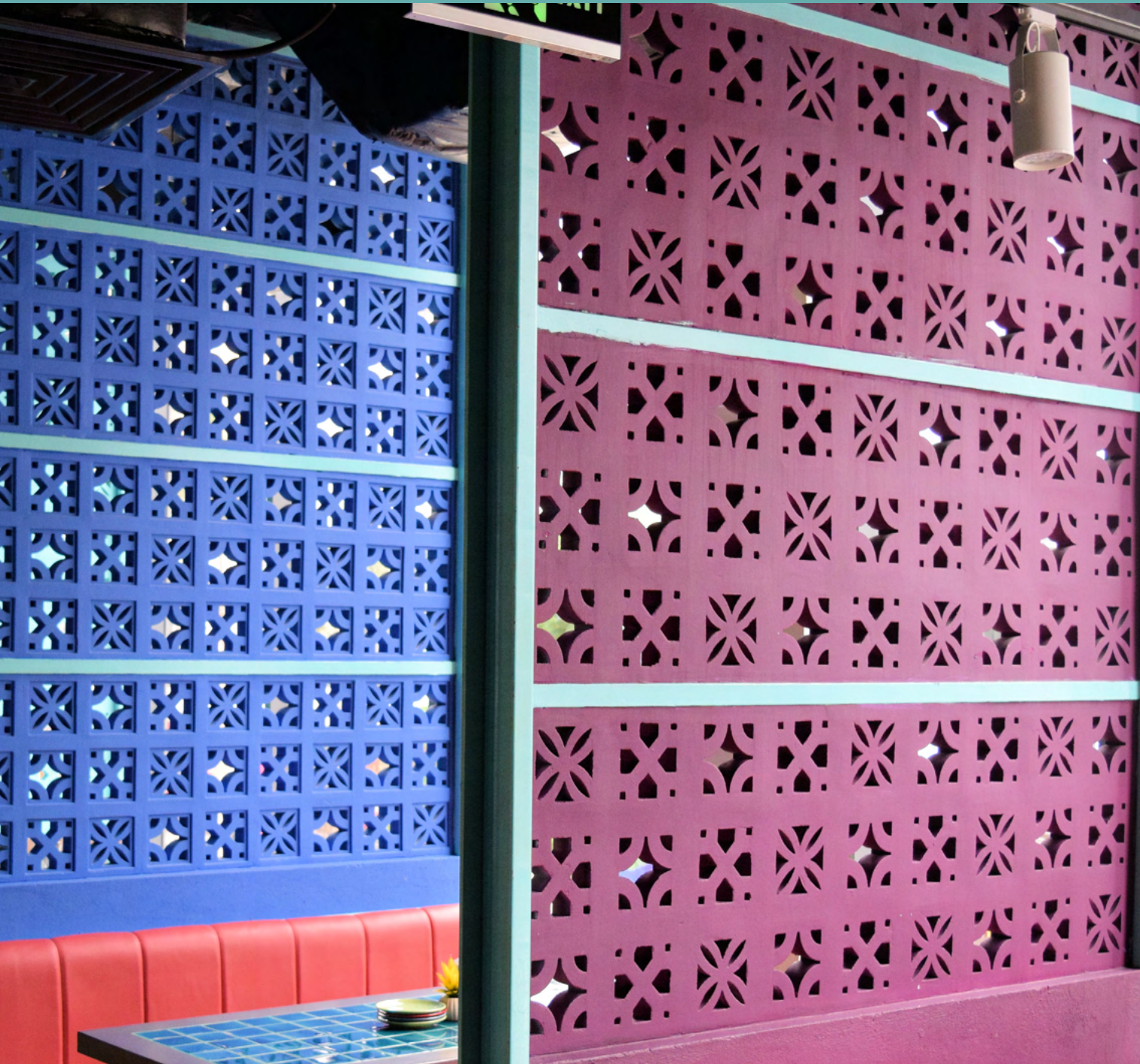

Breeze Blocks

A NEW GENERATION

Villa Lagoon Tile's Breeze Blocks are adding to the revival of mid-century modern architecture, with a more refined version of the pattern blocks of the original era. We like to call them "Breeze Blocks 2.0". These hand crafted blocks use finer sand aggregate and hydraulic presses, rather than the course cast products of the past. This makes these blocks thinner, smoother, and generally more appealing than their "1.0" counterparts.





8" CONCRETE BREEZE BLOCKS

SHOWN IN NATURAL WHITE



IBIZA



COZUMEL



SANTORINI



KAUAI



TAHITI



CAPRI



BALI

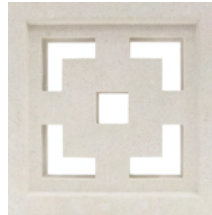

TONGA



SAMOA



FIJI

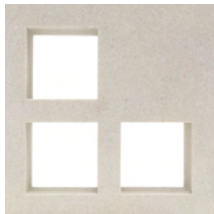

ANTIGUA



CURACAO

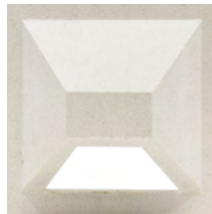

HAWAII



MALDIVES



MAUI

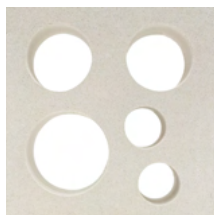

JAMAICA



ARUBA



BARBADOS



ZANZIBAR



MYKONOS

8" CONCRETE BREEZE BLOCKS

SHOWN IN NATURAL WHITE

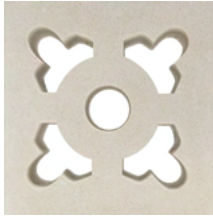

PALAU

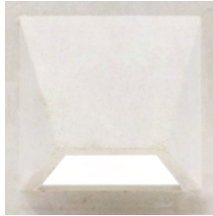

MOLOKAI

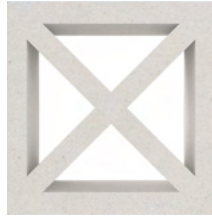

TORTUGA



LANAI

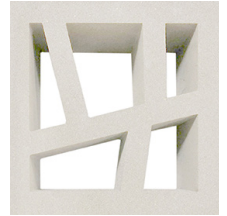

KYUSHU

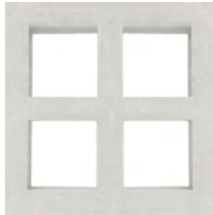

BORNEO

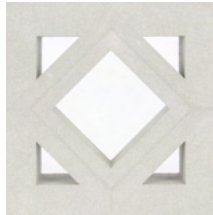

ANTILLES



SUMATRA

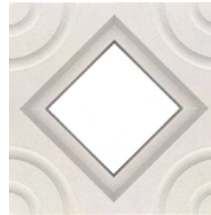

TURKS



CAICOS



8" CONCRETE BREEZE BLOCKS

SHOWN IN NATURAL WHITE



SEYCHELLES

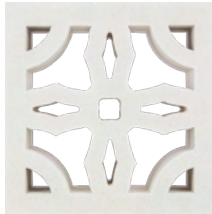

MOOREA



CRETE

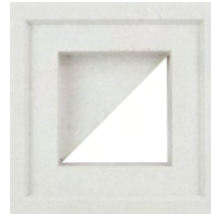

CYPRUS



SARDINIA

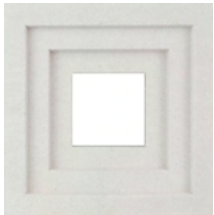

PALAWAN

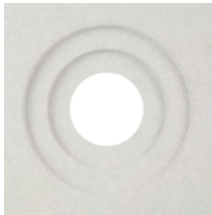

LUZON

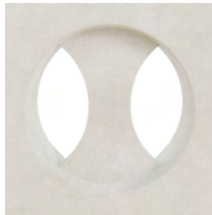

KAHOOLAWEE



CORFU



BORA BORA



Structural Grooves

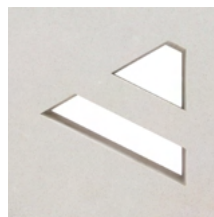

TINIAN

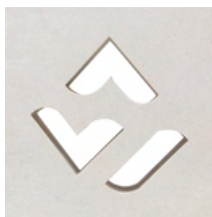

ROTA

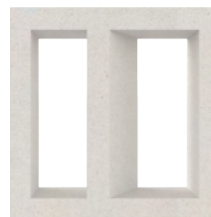

SAINT LUCIA

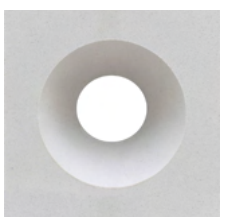

ANEGADA

*SHOWN IN NATURAL GRAY

Format: 7 1/2" Square
 Dimension: 190x190x65 mm
 Coverage: 2.3 PCS Per Square Foot

Weight: 5-8 lbs Each
 Composition: White Portland Cement
 Fine & Course White







12" CONCRETE BREEZE BLOCKS

SHOWN IN NATURAL WHITE



LARGE IBIZA



LARGE BERMUDA

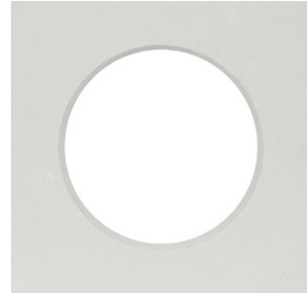

LARGE TORTOLA



LARGE CATALINA

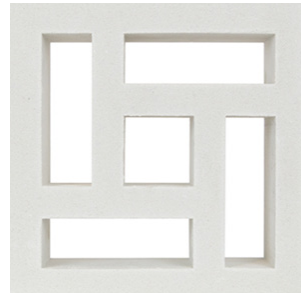

LARGE BARBADOS

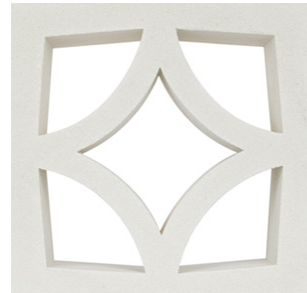

LARGE MALTA

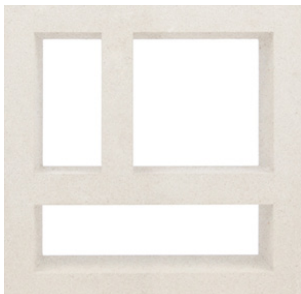

LARGE KAUAI

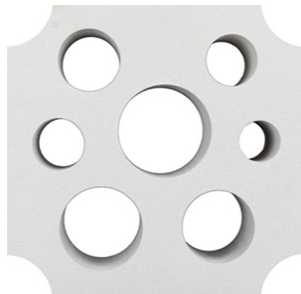

LARGE AZORES



LARGE ANEGADA

12" CONCRETE BREEZE BLOCKS



LARGE BELIZE

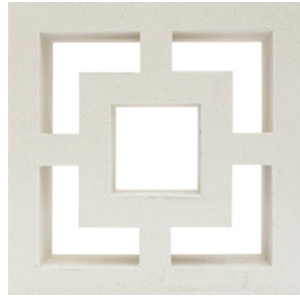

LARGE TONGA

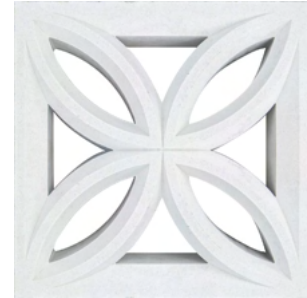

LARGE BEVELED IBIZA



LARGE KORCULA

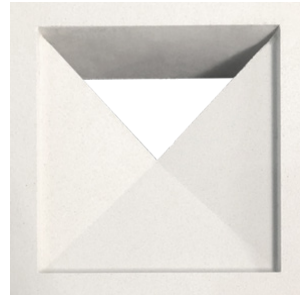

LARGE MALLORCA



LARGE BEVELED COZUMEL



LARGE MENORCA

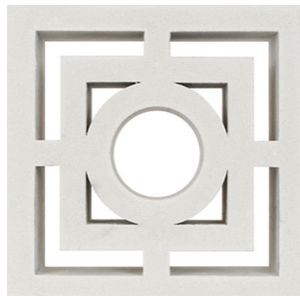

LARGE CAYMAN

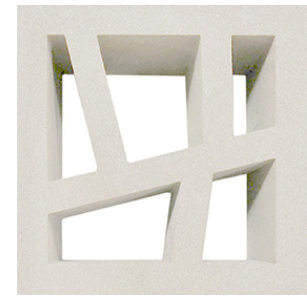

LARGE KYUSHU

Format: 11 3/8" Square
 Dimension: 290x290x90 mm
 Coverage: 1.02 PCS Per Square Foot

Weight: 16 -25 lbs Each
 Composition: White Portland Cement
 Fine & Course White Sand



SPECIAL SHAPES

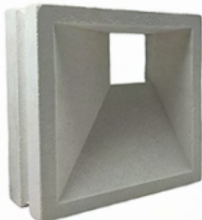

AKUTAN



GUAM



MILOS



NAXOS

7 1/2" Square
190x190x80 mm
2.3 PCS Per Square Foot
6.6 lbs - 7.8 lbs Each

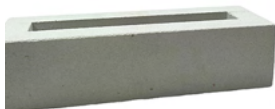

ELBA
12" Rectangle
300x100x120 mm
3.8 Pieces Per Square Foot
7.27 lbs Each



RAPA NUI
7 1/2" Triangle
190x160x65 mm
5.5 Pieces Per Square Foot
3.3 lbs Each



CORSICA
12" Rectangle
300x100/120x120 mm
3.2 Pieces Per Square Foot
9.0 lbs Each



VANCOUVER
11 3/5" Triangle
295x295x65 mm
2.4 Pieces Per Square Foot
6.6 lbs Each



BARATANG
12"x 7 7/8"
300x190x 90 mm
1.65 Pieces Per Square Foot
10.2 lbs Each

**CUSTOMIZED
DESIGNS
AVAILABLE**

SPECIAL SHAPES

WINDBREAKER Solid Breeze Blocks

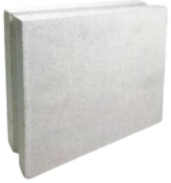

Windbreaker Sixty-Five
7 1/2" Square
190x190x65 mm
2.3 Pieces Per Square Foot
10 lbs Each



Large Half-Windbreaker Ninety
11 3/8" Rectangle
290x145x90 mm
8 Pieces Per Square Foot
17 lbs Each



SANDSCAPE Wall Decor

Multiple plank sizes in 1/2" thickness:

- 200x50x12 mm (8x4")
- 200x100x12 mm (8x2")
- 300x100x12 mm (12x4")
- 300x50x12 mm (12x2")

CAN BE
CUSTOM
MADE IN
ALL BREEZE
BLOCK
COLORS



SPECIAL DIMENSIONS

RAPA NUI

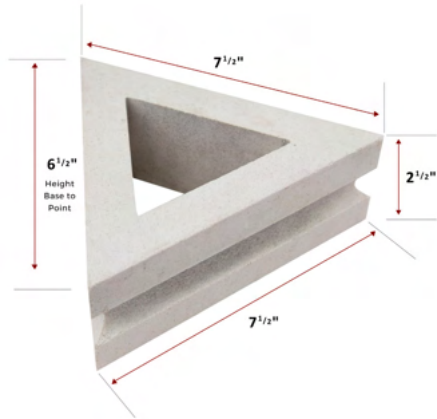

ELBA

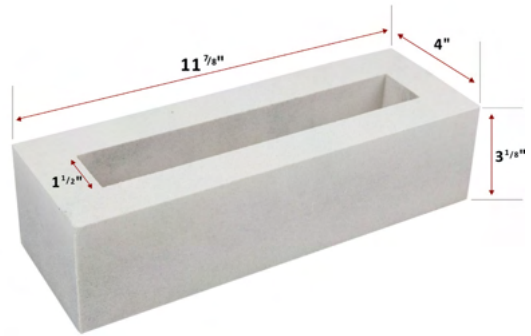

BARATANG

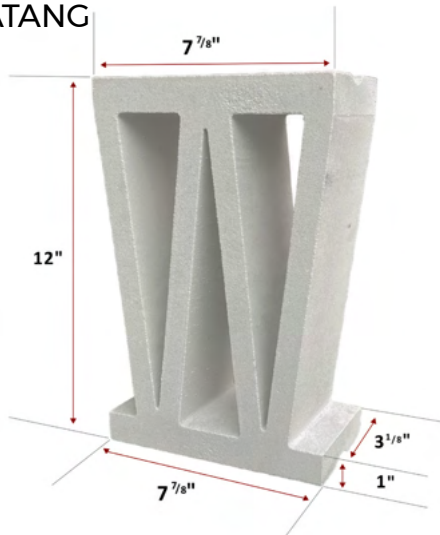

CORSICA

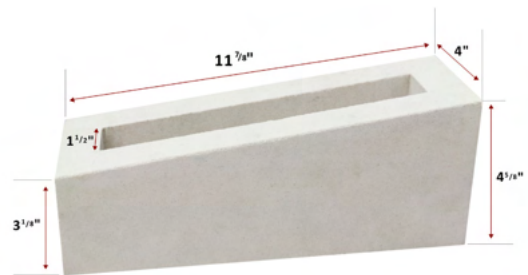

BREEZE BLOCKS

Color Options



Natural Gray

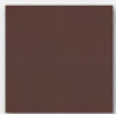

Brown

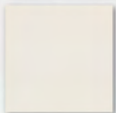

Natural White

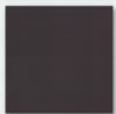

Black



Green



Blue



Yellow



Red



COLOR BLOCKS
MADE TO ORDER
Contact Us for Minimum
Order Quantity (MOQ)

SELECT
BLACK
BREEZE
BLOCKS
IN STOCK





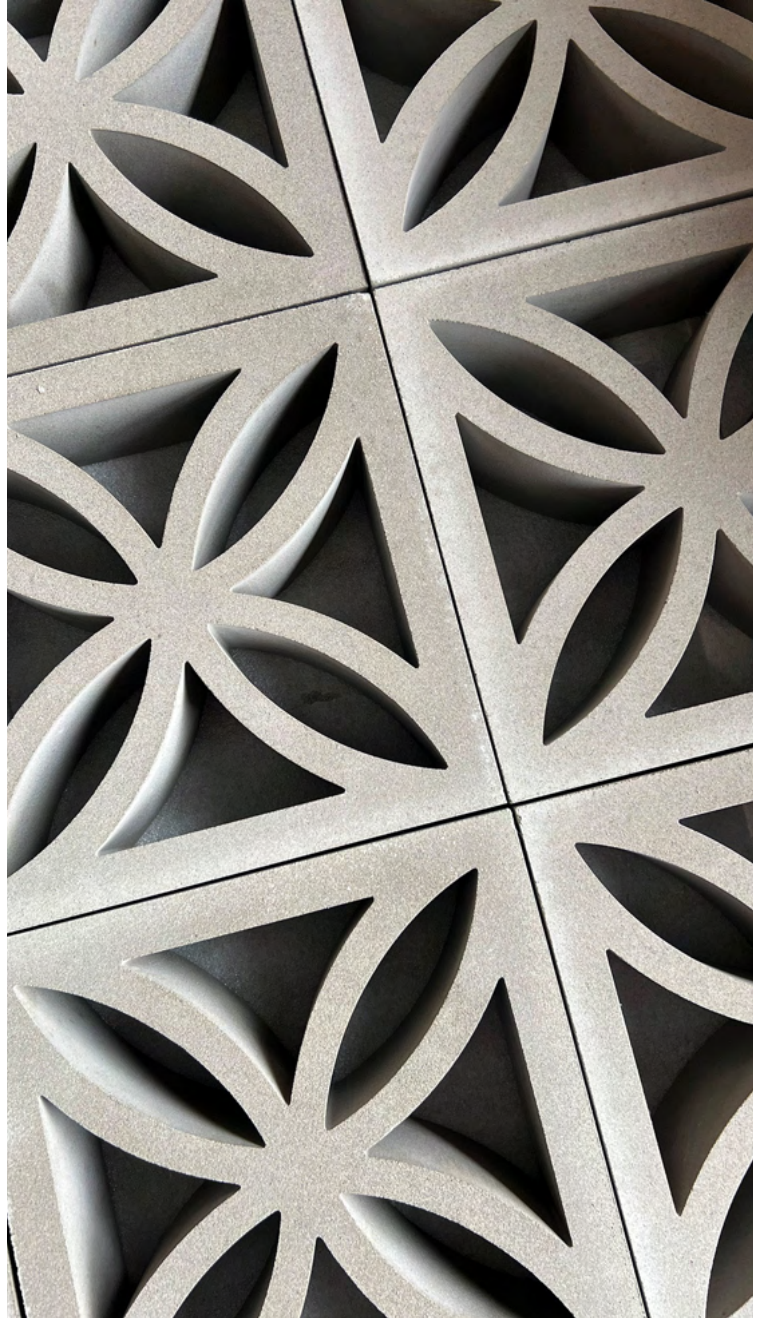





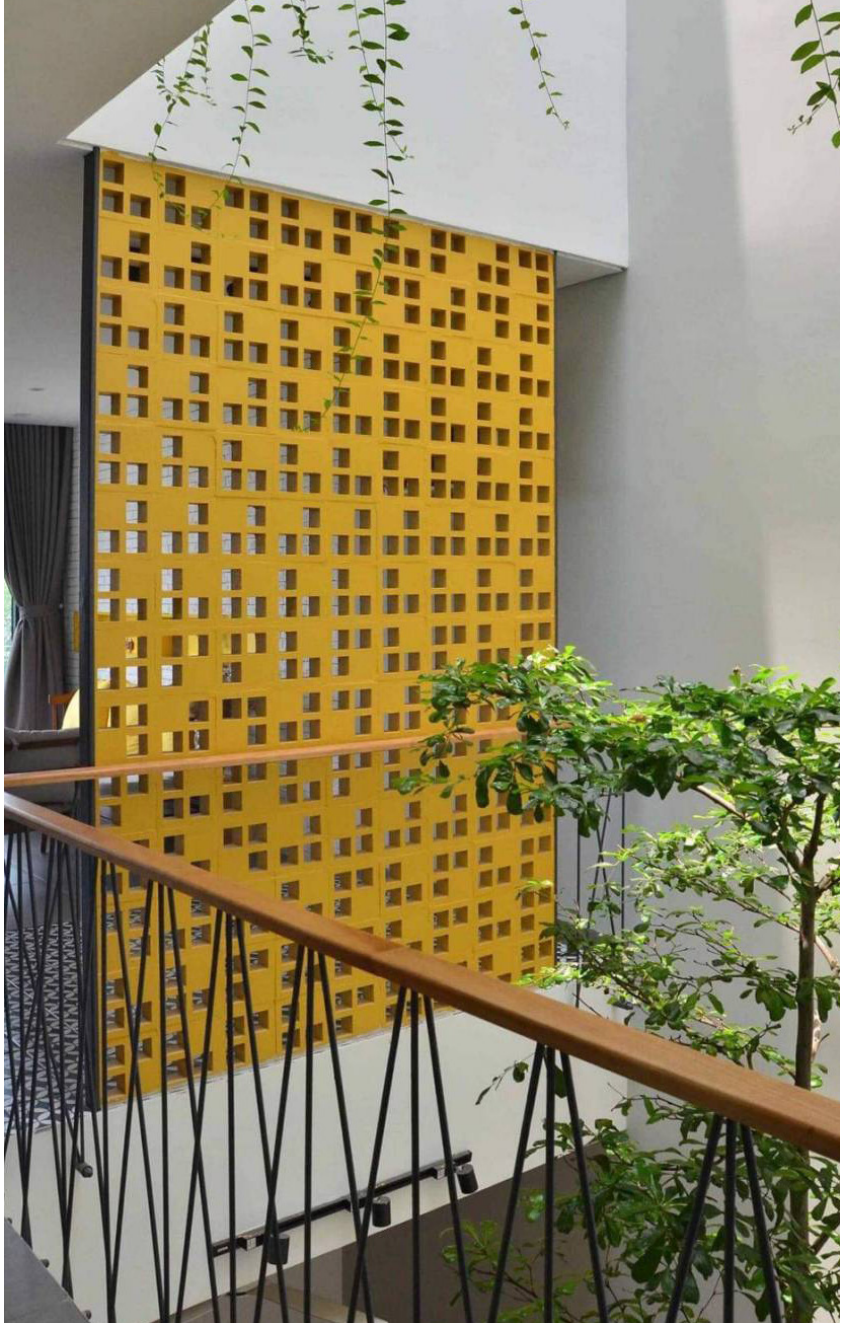



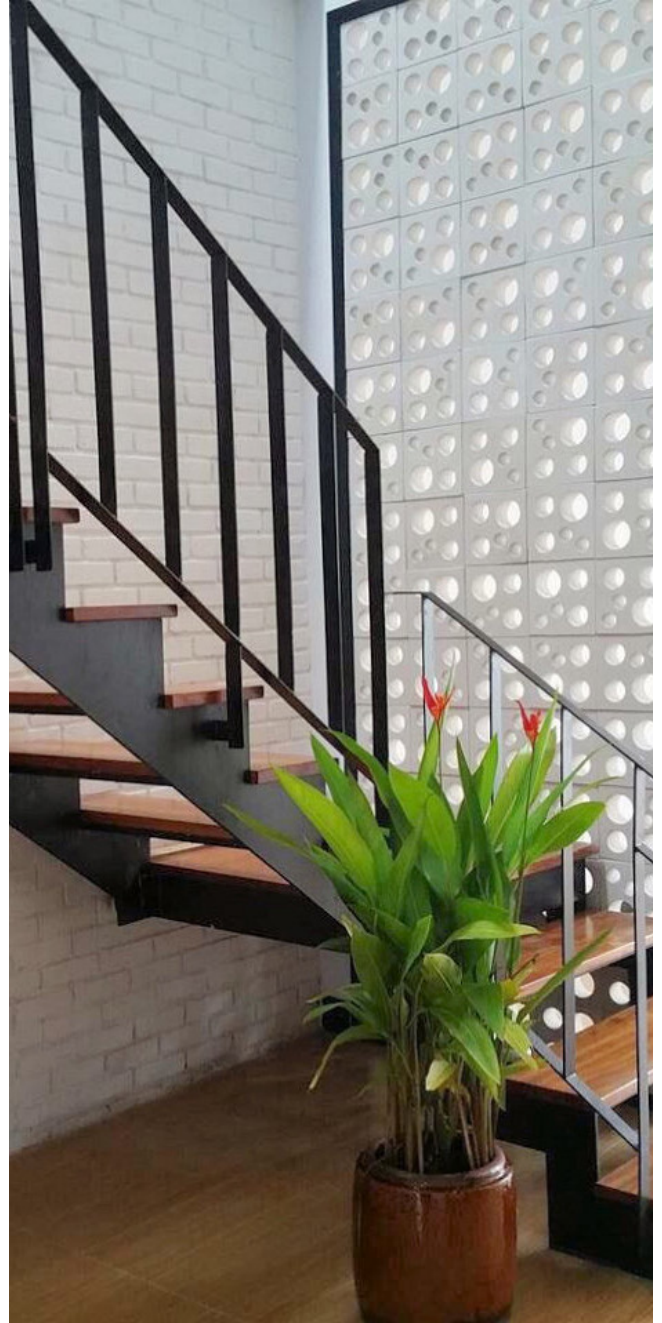



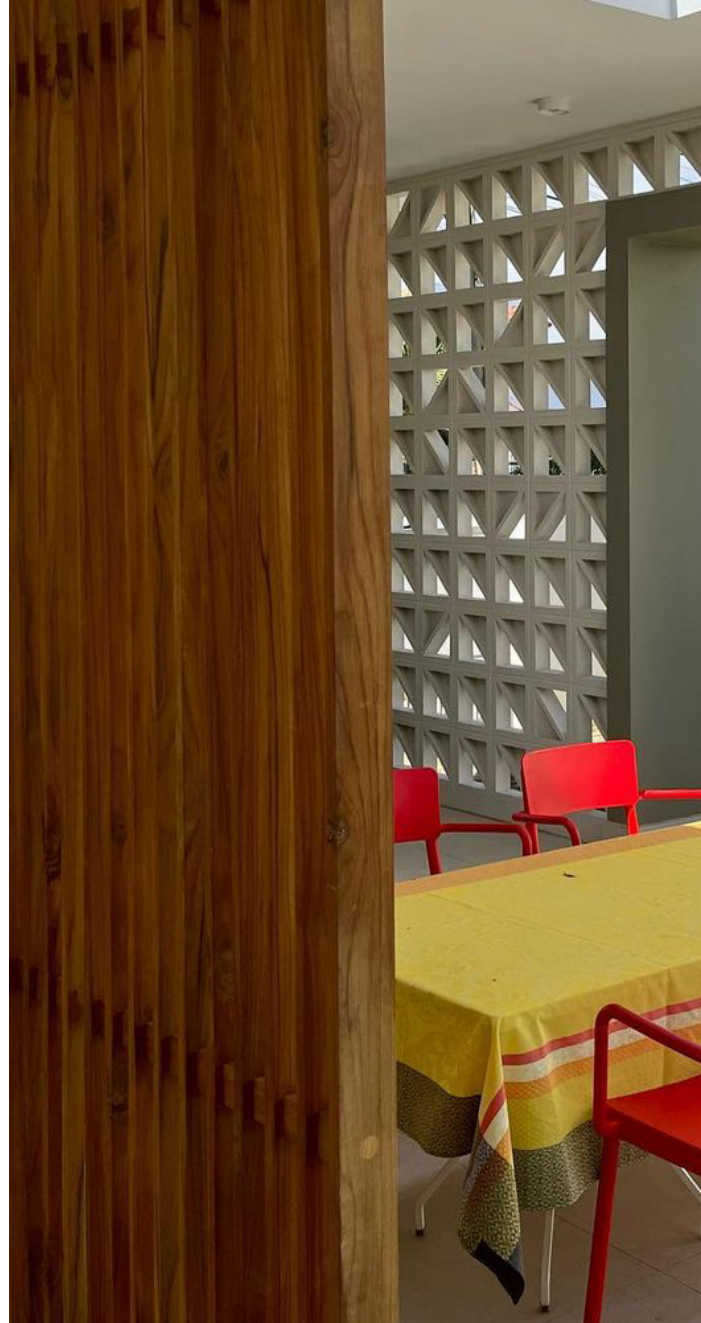
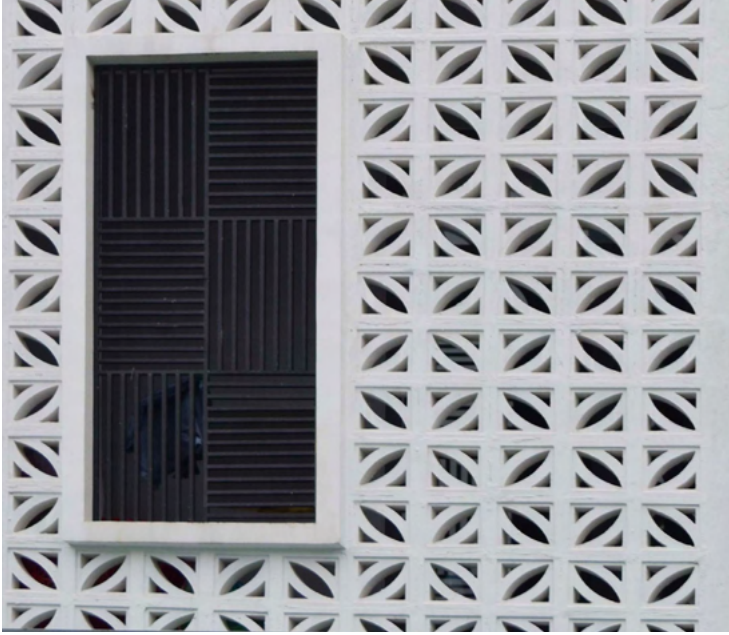











garyjustiss



triplefarmhouse



dear_saint_giles



susanpadvayosca



triplefarmhouse

SHARE YOUR PHOTOS - TAG US @VILLALAGOONTILE





Installing Breeze Blocks

Understanding Installation Requirements

Breeze Blocks are decorative, and are not intended for load-bearing walls. Breeze block wall spans should not exceed 3 meters (9.8 feet). Structural pilasters, steel H-beams, steel bar plates, or other similar vertical supports should be incorporated to allow for longer walls. Lintel beams or similar load-bearing structures should be incorporated for walls exceeding 2.5 meters (8 feet) in height. These supports should meet your local building code, and be planned by a structural engineer, general contractor, or other licensed professional.

Our Breeze Block designs incorporate channels on all four sides (8" block), or two sides (12" block) to accommodate steel dowl or rebar reinforcement, to anchor installations to the surrounding structure, and increase the wall's flexural strength. Consider using epoxy-coated rebar, or other forms of corrosion protection, to extend the lifespan of your structure.



Block 12"

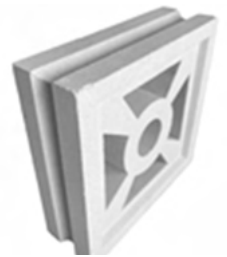

Block 8"

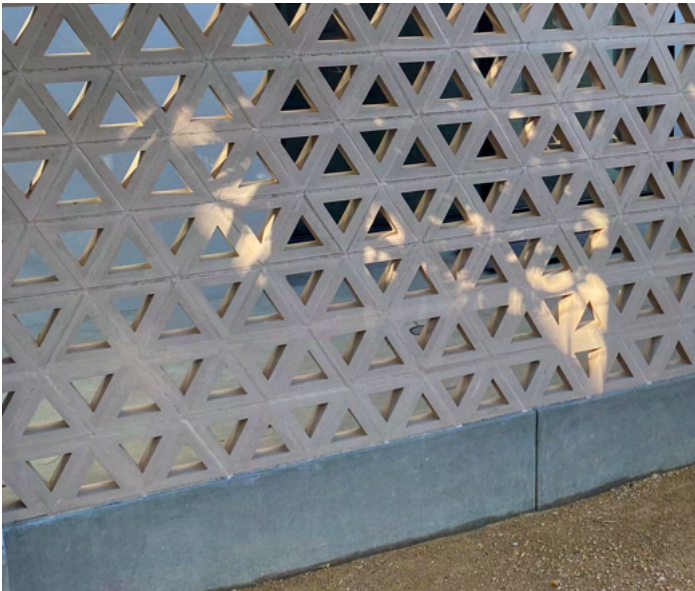

The steps listed here lay out general guidelines, however may not be sufficient for every application.

Please make sure that your installation procedure follows local building codes.

Preparing the Foundation

Ensure a suitable foundation and substrate that is:

- » Capable of bearing the weight of the screen wall segment..
- » Clean and level.
- » Suitable for mortar installation

Selecting the Mortar

Use conventional cementitious mortar (mortar mix, masonry mix) of an appropriate grade for the project. Note that white mortars are available, which use only white sand, and white cements. Ensure that the mortar purchased meets ASTM requirements for the application.

The thickness of the mortar layer should be around 2 inches. It will aid in maintaining enough mortar layer binding when the weight of the top layers forces the lower mortar layers to become thinner.

Breeze Blocks are decorative, and are not intended for load-bearing walls. Breeze block wall spans should not exceed 3 meters (9.8 feet). Structural pilasters, steel H-beams, steel bar plates, or other similar vertical supports should be incorporated to allow for longer walls. Lintel beams or similar load-bearing structures should be incorporated for walls exceeding 2.5 meters (8 feet) in height. These supports should meet your local building code, and be planned by a structural engineer, general contractor, or other licensed professional.

Understand and follow the directions for the mortar used.



Cement Needs Water to Cure

While it is easy to think of waiting for cement to cure as “drying”, it is actually a chemical process which consumes water, and continues forever. Luckily, almost all of the strength is achieved in the first 28 days, and about 70-75% of that strength is achieved in the first 7 days.

In preparation for setting the blocks, submerge them momentarily in water (at least 1 minute). This ensures that the dry blocks do not absorb too much moisture from the mortar, preventing the joints from curing properly.

After laying the blocks, frequently water the installation a minimum of 4 times a day for 5 days, however up to 10 times per day for a full 7 days is preferred.



Installing Breeze Blocks (continued)

Installation Method

Install by using standard masonry techniques.

- » Begin your installation at corners or against pilasters, working towards the middle.
- » Use a 5mm-10mm grout joint (approx $\frac{3}{8}$ ") for 8" block; or use a 10mm - 20 mm grout joint (approx $\frac{4}{7}$ ")
- » Maximum 2cm grout joint (approx $\frac{3}{4}$ ").
- » Insert steel reinforcement every 3rd course (for 7.5" blocks).
- » Make sure not to build too fast for the selected mortar. Your professional mason will know if the grout has cured enough, before continuing with higher courses.

After Installation

- » Make sure to maintain proper hydration for 7 days.
- » Expect about 30 days before the installation can be painted, or other finishes applied, depending on the local climate.

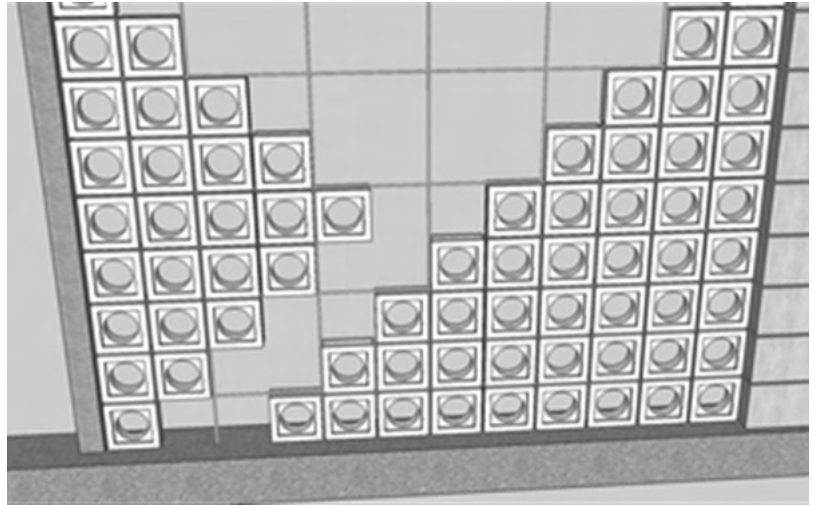

Conclusion

- » Breeze Block installation is not a DIY project.
- » Installation should be done by a professional mason.
- » The project should be overseen by a licensed general contractor.
- » Larger installations should be planned by a structural engineer.
- » Local building codes supersede any recommendations in this document.



CEMENT TILE • TERRAZZO • BREEZE BLOCKS • GLAZED ZELLEGE • TERRACOTTA



MORE TO EXPLORE AT VILLALAGOONTILE.COM

info@villalagoontile.com • 251.968.3375



VillaLagoonTile.com

Handcrafted Tile & Breeze Blocks